

GIGA

STACK SERIES



OWNER'S MANUAL



STORAGE SOLVED

A PRODUCT OF ARK BATTERY & MILLERTECH

Phone: 330-57RUBIX (330-577-8249) | Email: support@rubixbattery.com

TABLE OF CONTENTS

WHAT'S INCLUDED	1
TOOLS NEEDED	1
UNPACKING YOUR BATTERY	2
SAFETY & ENVIRONMENT	3
WIRING COMPARTMENT GUIDE	4
BATTERY IDENTIFICATION	5
LCD GUIDE	6
INSTALLATION	14
STACKING BATTERIES	14
CABLING GUIDE	15
NETWORKING GUIDE	16
PROGRAMMING GUIDE /	
INVERTERS SUPPORTED	18
ADJUSTING CHARGE VOLTAGES	
(CLOSED LOOP COMM ONLY)	19
OPEN LOOP INSTALLATIONS	20
SOL-ARK CONNECTION	21
RAPID SHUTDOWN	23
GENERAL SPECIFICATIONS	24

WHAT'S INCLUDED



BATTERY



**WIRING
COMPARTMENT
COVER**



**PARALLELING
BUSBARS (2)**



**PARALLELING
NETWORK
CABLE**



**TERMINAL
COVERS**

TOOLS NEEDED

The following tools are required for opening a battery crate:

- Hammer
- Chisel (or large straight screwdriver)

The following tools are required for installing your battery bank:

- Crescent wrench or open end ½" wrench or socket
- Torque wrench
- DC volt meter
- Utility razor knife



CAUTION

Always use caution when working with tools, especially tools with sharp edges!

UNPACKING YOUR BATTERY

Use a hammer and chisel (or large straight screwdriver) to pry open the shipping crate. The shipping crates are nailed or stapled shut as required by international shipping laws.

Batteries may be packed with Styrofoam and/or cardboard. Before heading to a job site, confirm how many batteries are in the crate as quantities and crate sizes are subject to change without notice.



CAUTION

CAUTION: Battery crates may have sharp, protruding nails.

CAUTION: Battery should only be unpacked by qualified battery installers.

CAUTION: Do not penetrate, dump, or otherwise damage the battery crate prior to the removal of the battery. Abusing the battery in this manner will void the warranty.

CAUTION: Do not store the battery in extreme temperature environments or in direct sunlight.

CAUTION: Do not touch the + or - terminals. High voltage may cause injury or death.

SAFETY & ENVIRONMENT



CAUTION

CAUTION: Do not short-circuit + and – terminals.

CAUTION: Do not reverse polarity when connecting charging/discharging equipment.

CAUTION: Do not install battery in an environment that is less than 32 degrees Fahrenheit or more than 120 degrees Fahrenheit.

CAUTION: Rubix Lithium batteries should only be installed in dry, climate-controlled areas.

CAUTION: Do not connect batteries in series. Only parallel connections are permitted.

CAUTION: Rubix Giga Stack batteries should only be paralleled with other Rubix Giga Stack batteries of the same model number. Do not parallel with other sizes, voltages or brands.

CAUTION: Batteries store electricity. Only qualified installers should work with Rubix batteries.

CAUTION: Always follow NEC guidelines to determine proper procedures, techniques, applicable accessories and sizing.

CAUTION: Never puncture, drop or shake Rubix batteries.

CAUTION: Never open a Rubix battery cover without the express permission of Rubix LLC or one of its authorized representatives.

CAUTION: Rubix batteries are designed and built to be used with solar and/or backup energy storage systems only. Do not use Rubix batteries in mobile or marine applications without the express permission of Rubix LLC or one of its authorized representatives.

CAUTION: Do not orient Rubix Giga Stack batteries in any position other than the intended horizontal position. Always use the Rubix Giga Stack base unit to install batteries. Do not exceed the maximum stack height as outlined elsewhere in this manual.

CAUTION: Do not install or assemble/stack your batteries on uneven or sloped terrain.

CAUTION: Do not offer coffee to your battery for wake-up purposes. Coffee shall only be consumed by the installers and that in moderate amounts and temperatures.

WIRING COMPARTMENT GUIDE

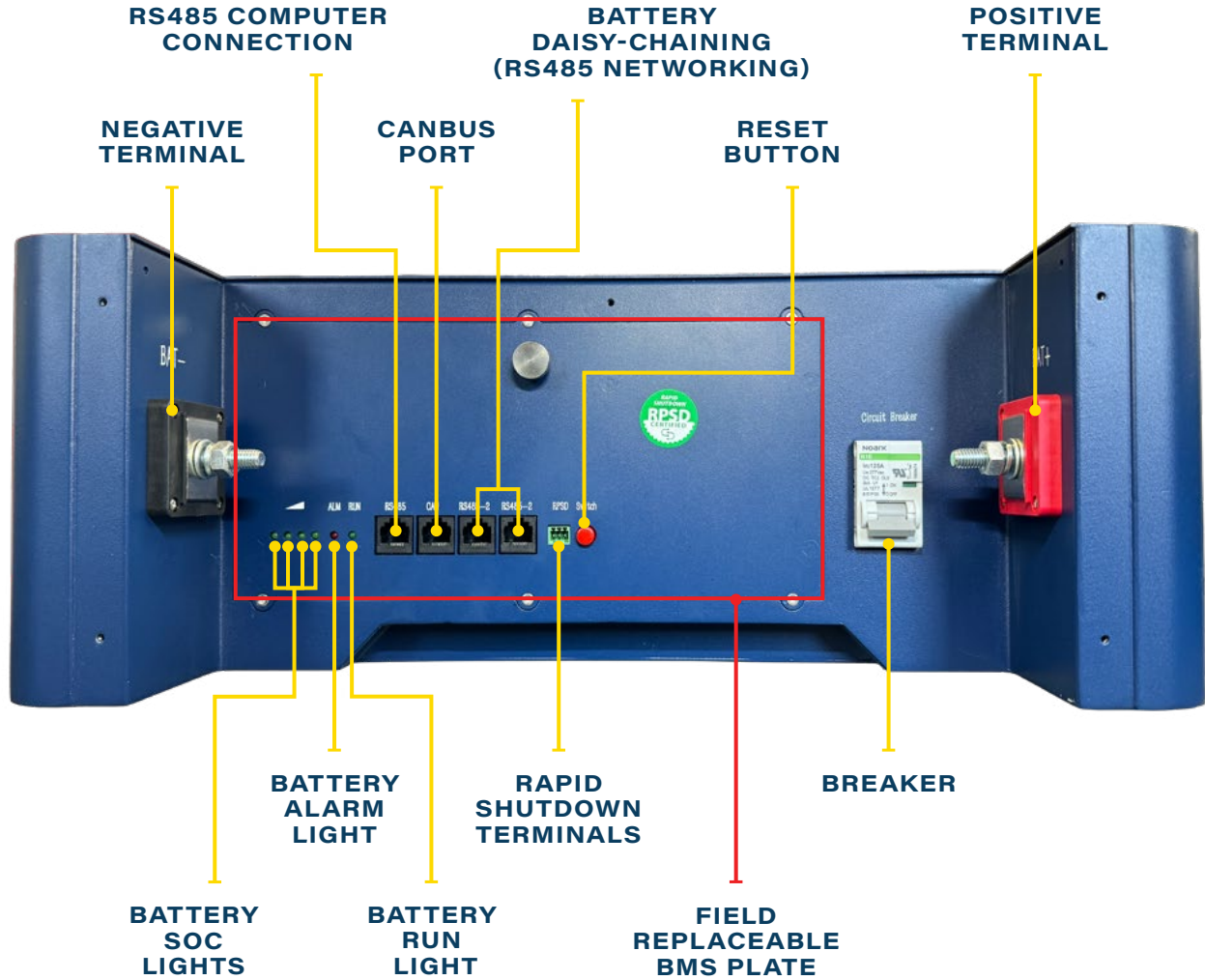

BATTERY IDENTIFICATION

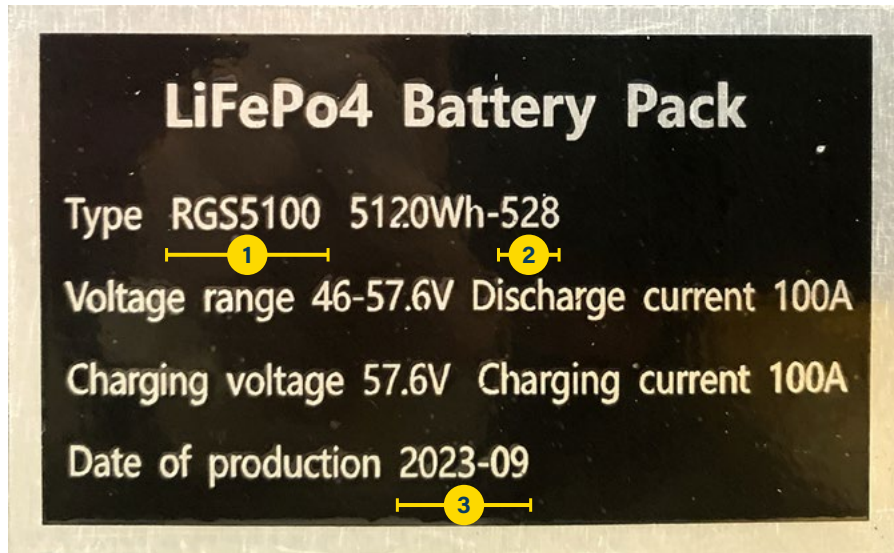

- 1** MODEL NUMBER
- 2** SERIAL NUMBER
- 3** PRODUCTION DATE

LCD GUIDE

IMAGE 1

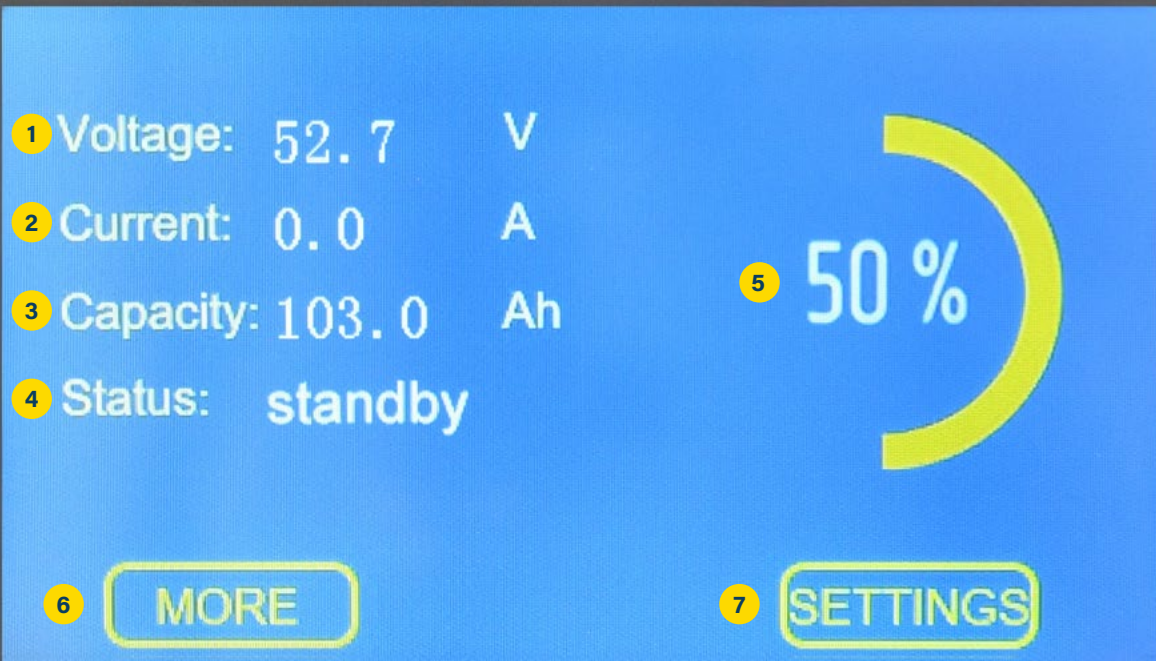

- 1 BATTERY VOLTS
- 2 BATTERY CURRENT (AMPS)
- 3 REMAINING CAPACITY
- 4 STATUS
- 5 BATTERY STATE OF CHARGE %
- 6 "MORE" LEADS TO IMAGE 2
- 7 "SETTINGS" LEADS TO IMAGE 6

LCD GUIDE

IMAGE 2

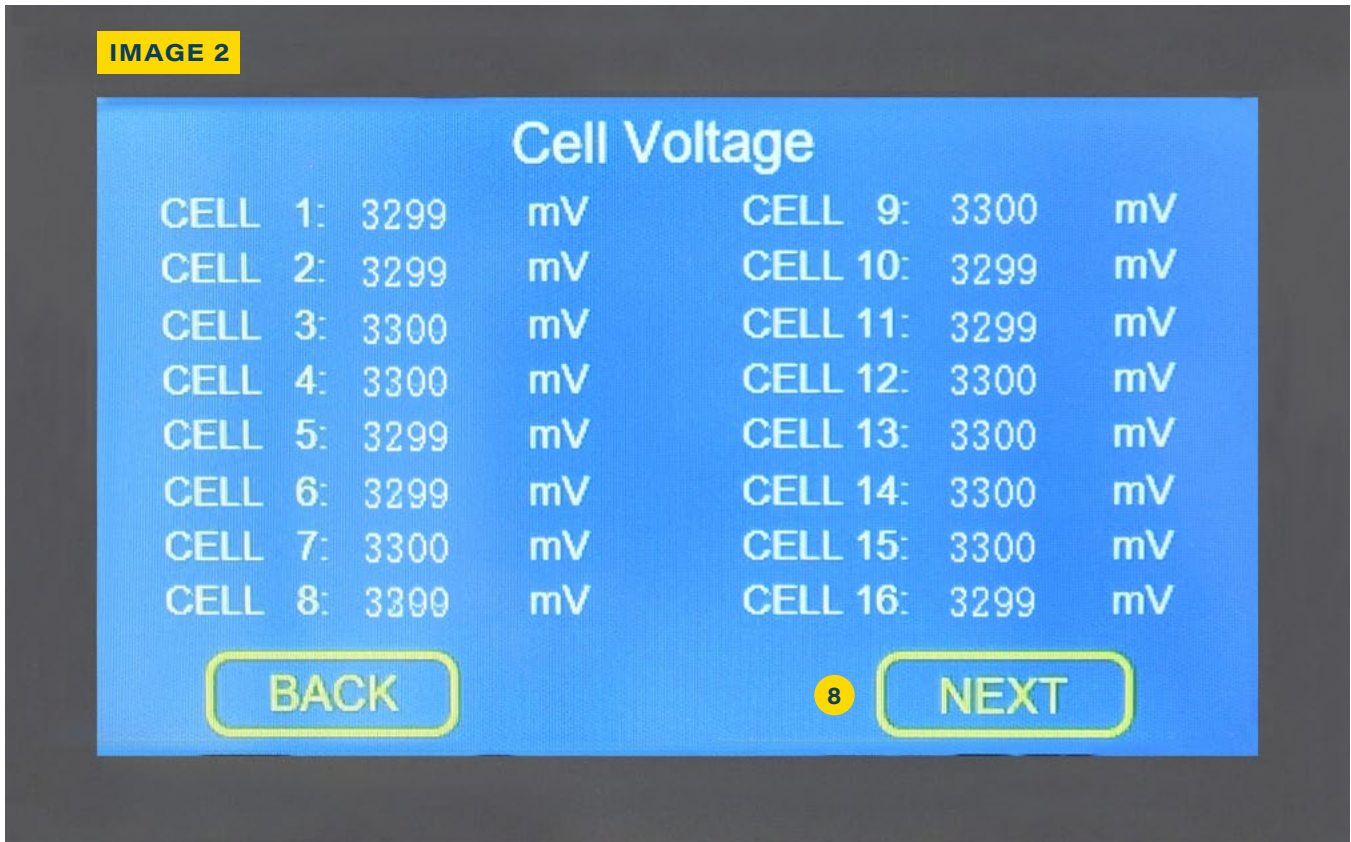
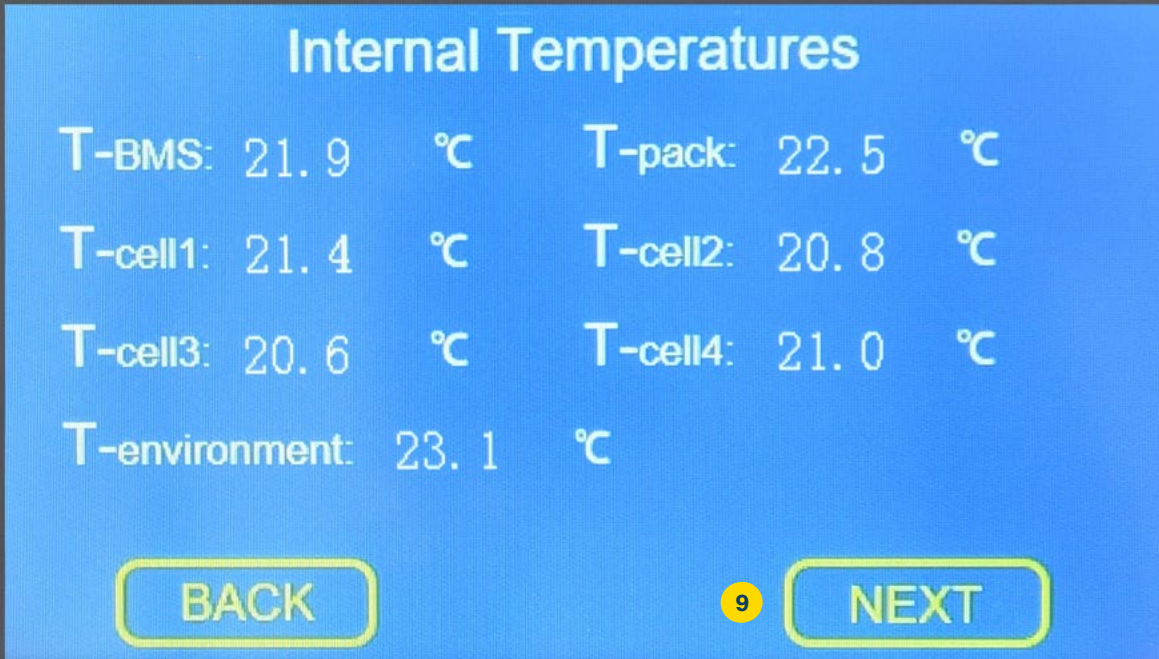

IMAGE 2 SHOWS THE VOLTAGES OF EACH INDIVIDUAL CELL

8 "NEXT" LEADS TO IMAGE 3

LCD GUIDE

IMAGE 3



9 "NEXT" LEADS TO IMAGE 4

LCD GUIDE

IMAGE 4

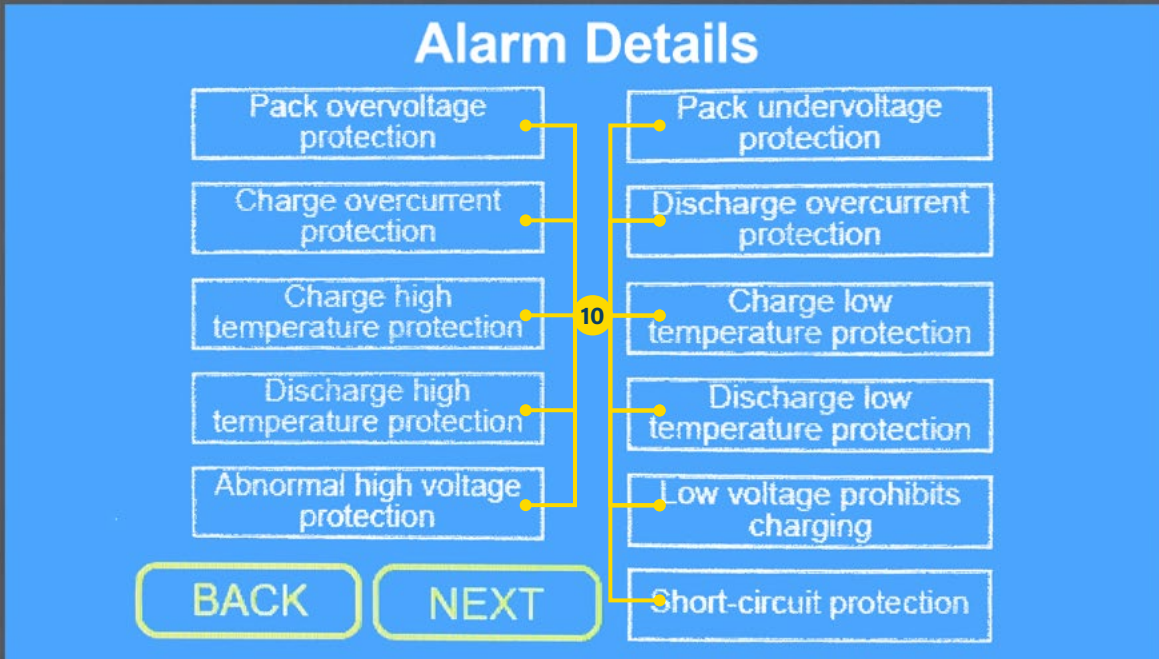

10 BLOCKS TURN RED WHEN THERE IS AN ACTIVE FAULT

11 "NEXT" LEADS TO IMAGE 5

LCD GUIDE

IMAGE 5

The LCD screen displays the 'Alarm logging' menu. At the top left, it shows 'Total 8' and 'Latest 8'. The main area contains a table with three entries. At the bottom, there are three buttons: 'BACK', 'Clear record', and a downward-pointing yellow triangle.

Alarm logging	
Total	8
Latest	8
1	25/06/2023 14:00:02 PM UTD
2	25/06/2023 14:00:29 PM UTD
3	04/01/2024 09:56:47 AM OCC

BACK Clear record

IMAGE 5 SHOWS THE ALARM LOGS AND TIME STAMPS

LCD GUIDE

IMAGE 6

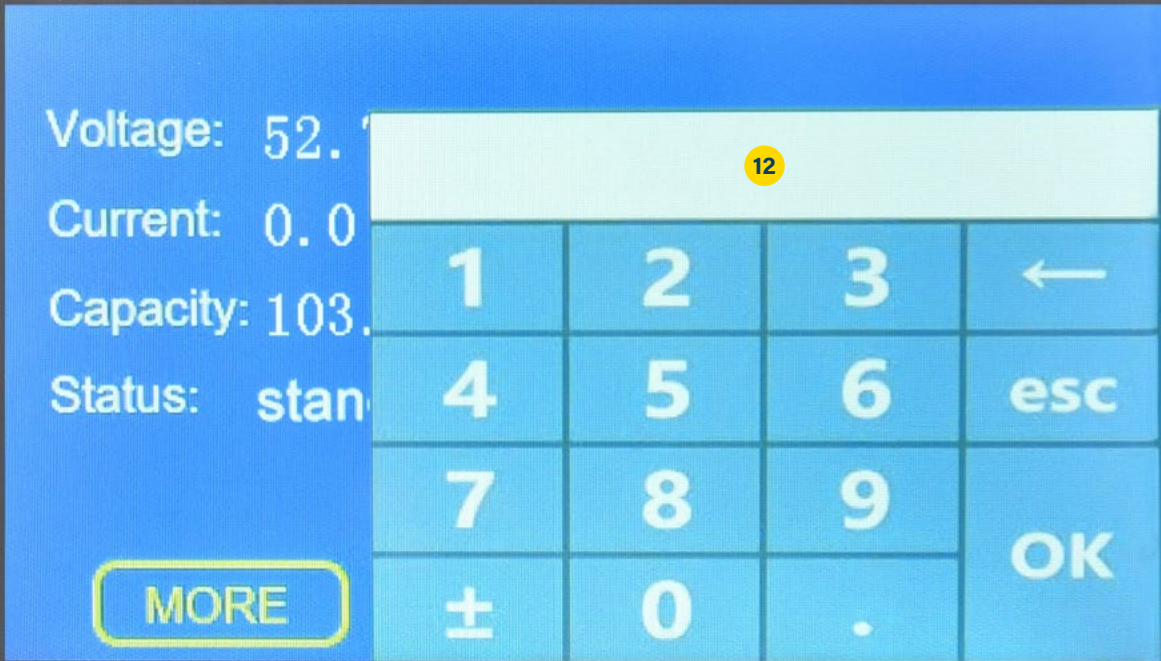

12 ENTER PASSWORD HERE AND THEN PRESS "OK"

LCD GUIDE

IMAGE 7

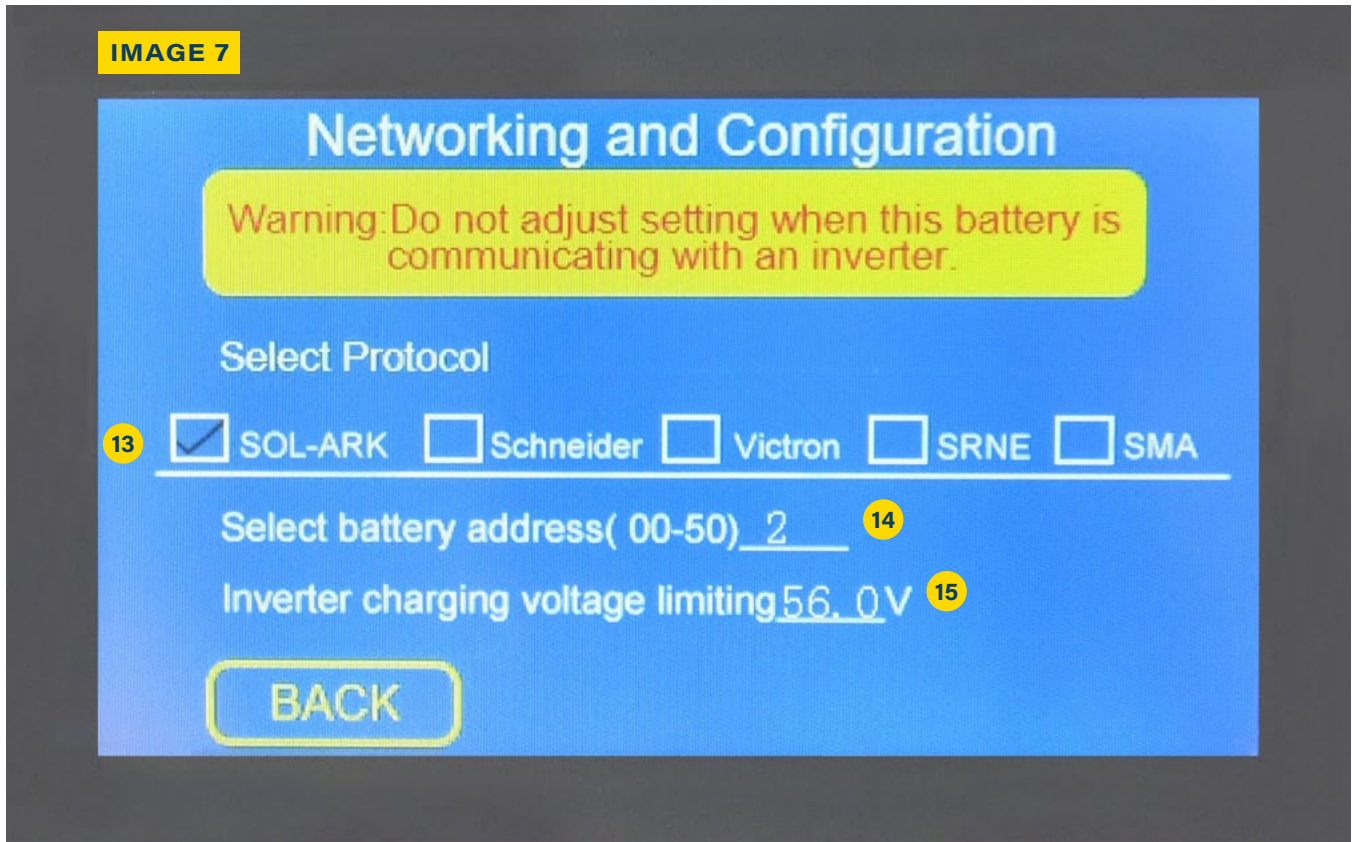

13 SELECT INVERTER TYPE

14 SELECT BATTERY ADDRESS

15 INVERTER CHARGING VOLTAGE LIMITER

LCD GUIDE

IMAGE 8

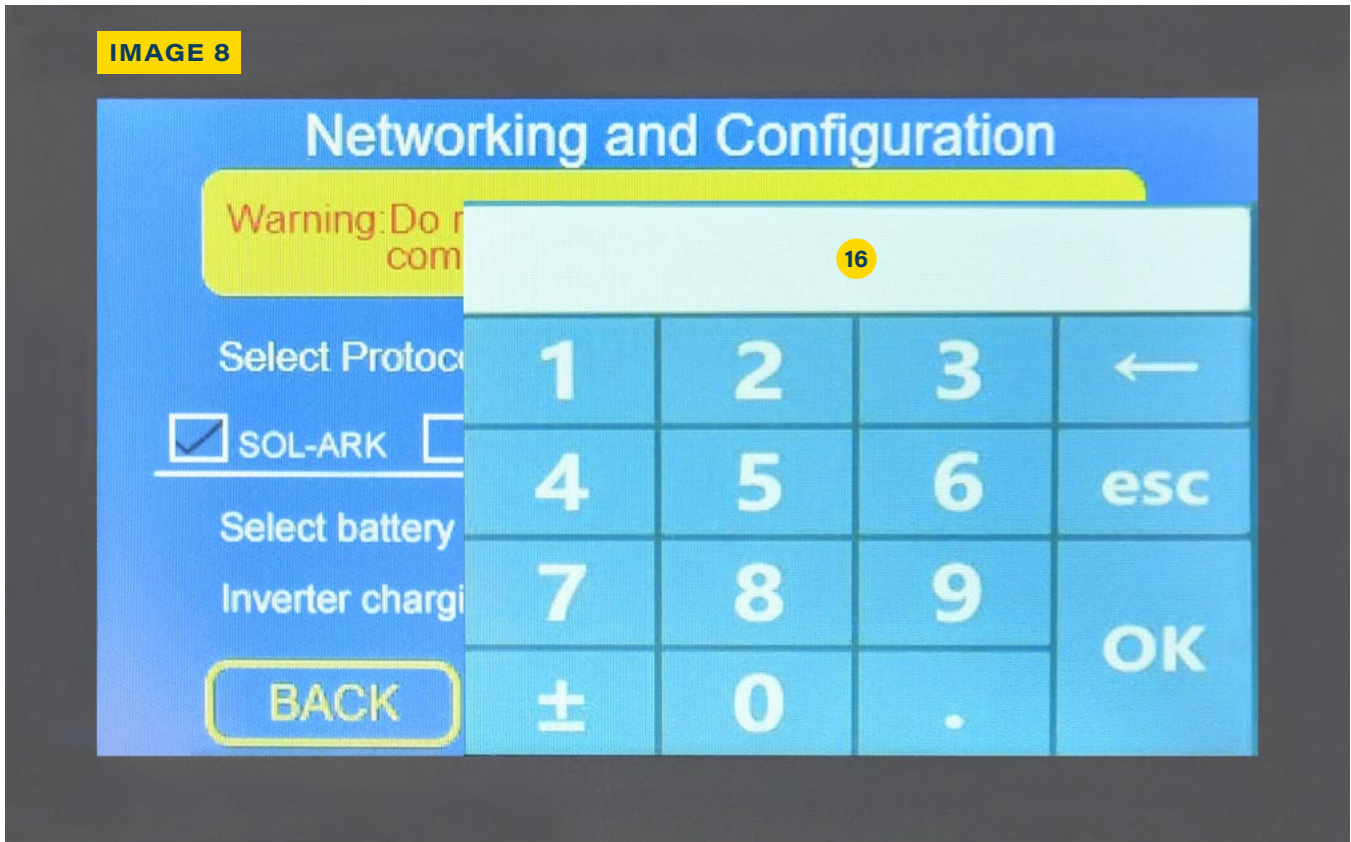

16 TYPE BATTERY ADDRESS HERE

INSTALLATION: SECTION A

SECTION A: STACKING BATTERIES

Rubix Giga Stack batteries are designed to stack on top of each other. Follow this sequence to stack your batteries.

1. Position the base unit in the proximity of the battery bank's long term position.
2. Lock all 4 casters on the base unit using the swivels that raise or lower the brake pads.
3. Stack the first battery onto the base unit.
4. Stack additional batteries on top of the first battery ensuring that the slots on the bottom of the battery slide over the posts of the battery below it. Properly installed, there should be no gap between stacked batteries.
5. Once the batteries are stacked, and all networking and cabling is completed, Unlock the casters and move the batteries to their correct and permanent position. Relock the casters so that the batteries will not move when accidentally bumped or pushed.

BATTERY SPACING AND CLEARANCES

Rubix Battery recommends the following clearances for all battery installations (see spec sheet)

- Minimum spacing between batteries and wall: **3 inches**
- Minimum spacing between parallel battery stacks: **4 inches**
- Minimum spacing between top of battery stack and solar equipment on wall: **6 inches**
- Minimum spacing between bank and water sources/conductors: **4 feet**

INSTALLATION: SECTION B

SECTION B: CABLING/PARALLELING

All Rubix batteries should be paralleled (positive to positive and negative to negative)

Never connect lithium batteries in series unless the manufacturer allows it.

See *image 9*.

1. Use the included busbars to parallel all batteries in the stack. See torque specs on page 25. Ensure that there are no washers between busbars or between busbars and battery terminals. Washers do not conduct current as well as busbar and terminal surfaces!
2. After all busbars are installed, install inverter cables cadre corner (positive on bottom battery, negative on top battery or vice versa). Cables can be brought in through the base unit and/or through the lid. Both the base and lid have 4 entry holes that are closed with a rubber punch-in. Use a knife to cut a small slit in the middle of the rubber punch-in and then push your cable through. The rubber is flexible enough to accommodate most common cable sizes while still keeping the rest of the hole sealed. It is not necessary that all cables are the same length as long as they are sized per NEC guidelines.
3. When paralleling multiple stacks, observe the following guidelines:
 - Keep stacks as closely together as reasonably possible.
 - Size paralleling (stack to stack) cables per NEC guidelines.
 - Ensure that paralleling cables are sufficiently protected from sharp edges.



17 PARALLEL BATTERY CABLE

INSTALLATION: SECTION C

SECTION C: NETWORKING GUIDE

Many of the networking settings in Rubix Giga Stack batteries are password protected. The password is 1981. Do not share it with people who are unauthorized to work on or program the battery. The password is not required for general monitoring purposes.

Rubix Giga Stack batteries communicate with various leading brand inverters. As of Dec. 2023, only communications with Sol-Ark are fully tested. Communicating with other inverter protocols is not supported without express permission from Rubix LLC or one of its authorized representatives.

PARALLEL NETWORKING:

- To communicate with inverters, all batteries in the bank should be parallel networked using the included network cables.
- Daisy chain each battery from the RS485-2 ports. It does not matter which port you use. No termination is needed at the last battery in the chain. When paralleling multiple stacks, use a standard Ethernet cable (not included) to daisy chain from stack to stack. See *image 10*.

BATTERY ADDRESS:

- Each battery in the bank should be assigned a unique address. Set the master battery (that is, the battery that will be communicating with the inverter) as 01. The second battery can be set as 02, the third battery as 03 and so forth. See *images 11 and 12*.



NOTE

Section C is recommended for open and closed loop applications.



18

USE INCLUDED NETWORK CABLES TO DAISY CHAIN BATTERIES FROM RS485-2 PORTS.

INSTALLATION: SECTION C

IMAGE 11

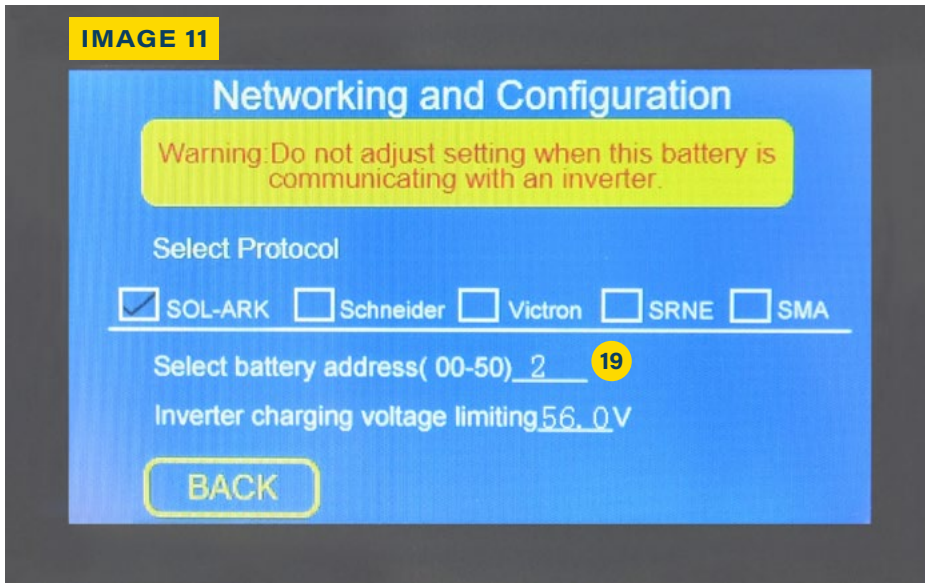

19 SELECT BATTERY ADDRESS.

IMAGE 12

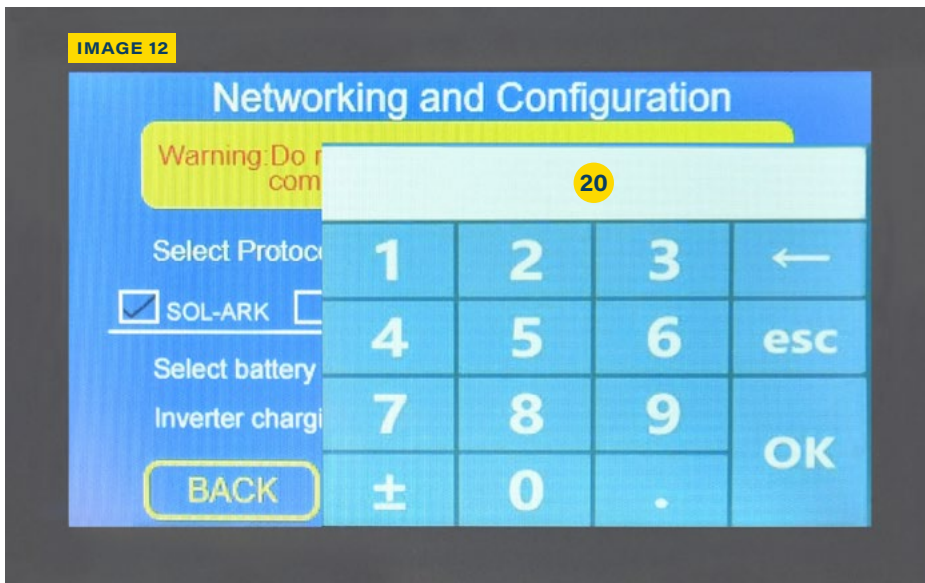

20 BATTERY ADDRESS: USE A DIFFERENT ADDRESS FOR EACH BATTERY. MASTER BATTERY SHOULD BE SET TO 1.

INSTALLATION: SECTION D

SECTION D: COMMUNICATION WITH INVERTERS

After assigning each battery a unique address number, connect a standard Ethernet cable (included with base and lid kit) from the CAN port of the master battery (the battery with the address set at 01) to the CAN or CANBUS port on the inverter.

See *image 13*.

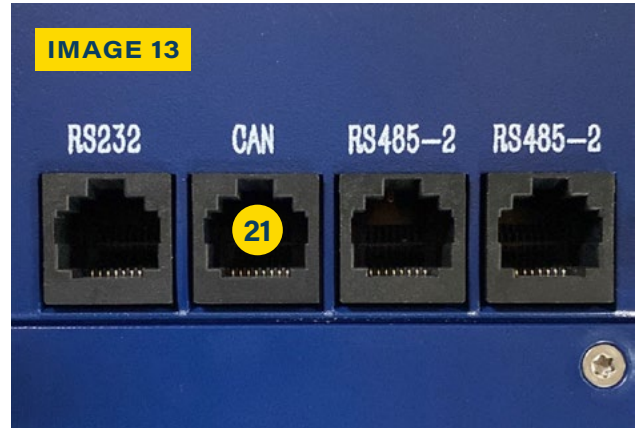

INSTALLATION: SECTION E

SECTION E:

ADJUSTING CHARGE VOLTAGES (CLOSED LOOP COMM APPLICATIONS ONLY)

Rubix Giga Stack batteries have a unique feature called multiway closed loop comm that allows flexible charge voltages when batteries are communicating with inverters. The maximum range is 55.0V-57.6V.

Many inverters only allow a single voltage value in closed loop communication. This means EQ, Absorb and Float will all show the same value. This creates challenges when trying to find a happy medium of fully charging batteries yet not 'floating' at a high voltage. We recommend the following:

24/7 GRID CONNECTION AND/OR BACKUP ONLY:

- Set the communicating voltage to 56.0V +/- 0.2V

SOLAR, GEN, OR OTHER CHARGING SOURCES THAT ONLY PERIODICALLY FULLY CHARGE THE BATTERY BANK:

- Set the communication voltage to 56.4V-57.0V



NOTE

This setting WILL NOT set or limit charge voltages in open loop applications! Open loop applications require that settings be made on your charging/discharging equipment, not on the batteries.

IMAGE 14

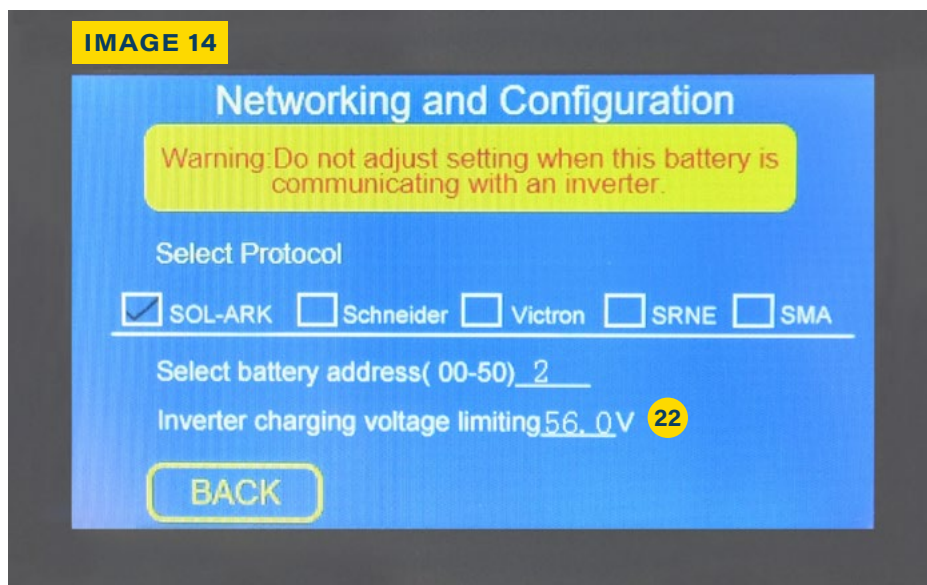

22

ADJUSTING CHARGE VOLTAGE

INSTALLATION: SECTION F

SECTION F: OPEN LOOP INSTALLATIONS

Rubix Giga Stack batteries can be installed in open loop applications. In many cases, this is preferred and allows the installer greater flexibility with settings.

The term 'Open Loop' simply denotes that there is no communication between the battery bank and the inverter(s). Open loop can be used even with inverters that support closed loop communication.

Tips for installing Open Loop systems:

1. Ensure that all charging and discharging parameters are programmed on your inverter, charge controller, or other equipment related to the system.
2. Install the daisy chain cables and set a unique address to each battery.
3. Double check that charging and discharging currents are limited as needed for systems with smaller battery banks.

CLOSED LOOP COMM WITH SOL-ARK

When communicating with a Sol-Ark inverter, follow this sequence:

1. Connect the CANBUS cable from the battery's CANBUS port to the Sol-Ark CANBUS port. (See image 15)
2. Navigate to Sol-Ark's Battery Setup page and set the parameters as outlined in the image on the next page. (See image 16)
3. The battery will auto populate the following on the Sol-Ark inverter:
 - SOC %
 - Battery capacity
 - Charge voltages

The battery will NOT auto populate the following on the Sol-Ark inverter:

- AC coupling
- Peak shaving
- Auto start settings
- Low battery shutdown and restart
- Max charge/discharge amps



23 CANBUS PORT ON SOL-ARK INVERTER

CLOSED LOOP COMM WITH SOL-ARK

IMAGE 16

The image shows a software dialog box titled "Batt Setup" with a blue header. It contains several input fields and checkboxes for configuring battery settings. The "Charge" tab is selected. The settings are as follows:

Field	Value	Option	Value
Batt Capacity	400Ah	Use Batt V Charged	<input type="checkbox"/>
Max A Charge	275A	Use Batt % Charged	<input type="checkbox"/>
Max A Discharge	275A	No Battery	<input type="checkbox"/>
TEMPCO	-0mV/C/Cell	BMS Lithium Batt	<input checked="" type="checkbox"/> 00
		Activate Battery	<input checked="" type="checkbox"/>

At the bottom of the dialog are two buttons: "CANCEL" and "OK".

RAPID SHUTDOWN

Rubix Giga Stack batteries are equipped with a Rapid Shutdown feature.

See *image 17*.

To use Rapid Shutdown:

1. Daisy chain each battery with the included wires. Use the center and right terminals on the RPSD plug. (See *image 18*)
2. Connecting the 2 terminals will activate the rapid shutdown feature. The red alarm (ALM) light will come on and the LCD display will say 'RPSD Activated.'

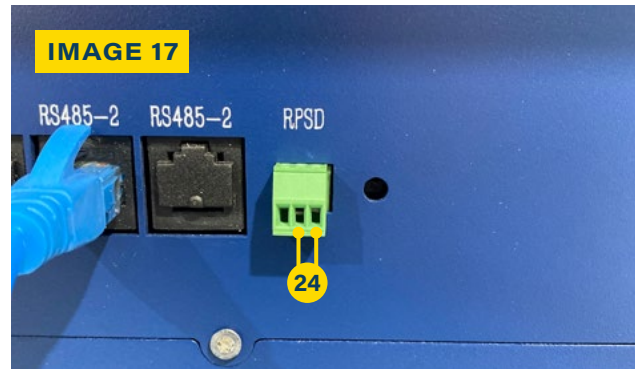

24 RAPID SHUTDOWN TERMINALS



25 RAPID SHUTDOWN DAISY CHAINING

GENERAL SPECIFICATIONS

	100AH, 48V	205AH, 48V
DESCRIPTION		
MODEL NUMBER	RGS51100	RGS51200
POWER RATINGS		
NOMINAL VOLTAGE	48	48
ACTUAL VOLTAGE @20% SOC	51.2	51.2
AMP-HRS	100	205
NAMEPLATE CAPACITY—KWH	5.12	10.5
CHARGING/DISCHARGING		
MAX CONTINUOUS DISCHARGE AMPS	90	140
RECOMMENDED DISCHARGE (MAX AMPS)	75	120
MAX CONT. DISCHARGE KW	4.6	7.2
SURGE DISCHARGE AMPS 0.5 (MICRO SECONDS)	1,000	1,000
SURGE DISCHARGE 10MS	200	300
MAX CHARGING AMPS—CONTINUOUS	70	120
PEAK CHARGING AMPS—30 MINUTES	80	140
RECOMMENDED VOLTAGE RANGE (CYCLING)	51-56.5	51-56.5
MAX VOLTAGE RANGE (CYCLING)	48-57.6	48-57.6
RECOMMENDED ABSORB VOLTS	56.8	56.8
MAX ABSORB VOLTS—SOLAR ONLY	57.6	57.6
ABSORB DONE AMPS/PER BATTERY	5	10
ABSORB DONE TIME (MINUTES)	10	10
FLOAT VOLTS	54.4	54.4
TEMP COMP—MV/DEGREES CELSIUS	0 °C	0 °C

GENERAL SPECIFICATIONS

	100AH, 48V	205AH, 48V
OPERATIONAL		
RATED CYCLE LIFE—100% DOD	4,000	4,000
RATED CYCLE LIFE—80% DOD	6,000	6,000
RATED CYCLE LIFE—50% DOD	8,500	8,500
RETAINED CAPACITY AT END OF CYCLE LIFE	80%	80%
MAX RECOMMENDED DISCHARGE VOLTS	51V (20%)	51V (20%)
INVERTER LOW BATTERY CUTOFF	48V	48V
LOW VOLT CUTOFF WAKEUP	44	44
HIGH VOLT CUTOFF WAKEUP	55	55
HIGH CURRENT CUTOFF WAKEUP	REVERSE DIRECTION OF CURRENT	
CERTIFICATION		
BATTERY CERTIFICATION	UL9540A	UL9540A PENDING
TRANSPORT CERTIFICATION	UN38.3	UN38.3
EXTERNAL		
HANDLES	INDENTED HANDLES	INDENTED HANDLES
TERMINAL TYPE	BOLT-ON M8	BOLT-ON M8
MAX TORQUE	20 FT LBS	20 FT LBS
ENVIRONMENT/INSTALLATION		
VENTILATION REQUIRED	NO	NO
MINIMUM TEMP (DEGRESS F)	32 °F	32 °F
MAXIMUM TEMP (DEGRESS F)	120 °F	120 °F
MAXIMUM BATTERIES PER STACK	6	4
IP RATING	50	50

GENERAL SPECIFICATIONS

	100AH, 48V	205AH, 48V
ENVIRONMENT/INSTALLATION (CON'T)		
OUTDOOR RATED	NO	NO
INSTALLATION POSITION	HORIZONTAL WITH BASE UNIT ONLY	HORIZONTAL WITH BASE UNIT ONLY
SAFETY		
BREAKER SIZE (AMPS)	125	150
BMS LOW VOLT CUTOUT	41+/-1 VOLT	41+/-1 VOLT
BMS HIGH VOLT CUTOUT	59+/-1 VOLT	59+/-1 VOLT
BMS LOW TEMP CUTOUT	32 °F	32 °F
BMS HIGH TEMP CUTOUT	135 °F	135 °F
PRESSURE VENTED CELLS	YES	YES
INTERNAL		
CELL CHEMISTRY	LIFEP04	LIFEP04
CELL FORMAT	PRISMATIC	PRISMATIC
BMS AMP RATINGS	150	200
BALANCING TYPE	IMPACTIVE	IMPACTIVE
CELL CONNECTION	WELDED BUSBAR	WELDED BUSBAR
MAX BALANCING CURRENT	1.1A	1.1A
TOUCHSCREEN LCD FEATURES		
SOC%	✓	✓
VOLTS	✓	✓
CHARGING/DISCHARGING AMPS	✓	✓
BALANCER STATUS	✓	✓
CELL VOLTAGES	✓	✓
FAULTS	✓	✓

GENERAL SPECIFICATIONS

	100AH, 48V	205AH, 48V
PHYSICAL DIMENSIONS & WEIGHT		
BATTERIES PER CRATE	4	2
CRATE DIMENSIONS	40" × 30" × 22"	40" × 30" × 22"
BATTERY DIMENSIONS	SEE DRAWING	SEE DRAWING
BATTERY WEIGHT	117 LB	199 LB
TOTAL CRATE WEIGHT	525 LB	437 LB

BOTH BATTERY MODELS USE THE SAME BASE AND LID

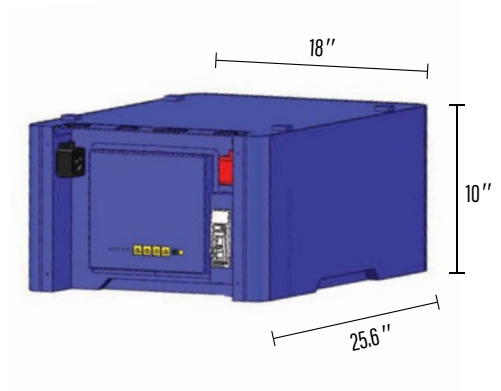
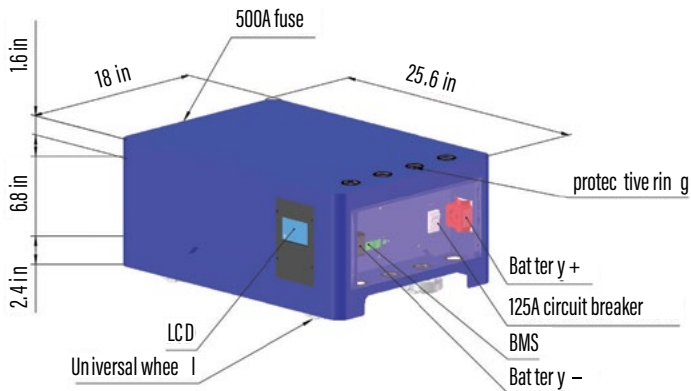

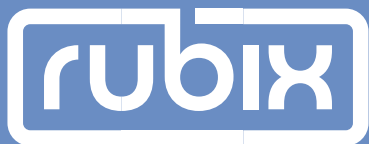

STORAGE SOLVED

MISSION

To deliver exceptional solar battery systems through practical, hands-on development, excellent service, and strong partnerships with the industry's professionals.

Rubix: Built by installers, for installers.

A PRODUCT OF ARK BATTERY & MILLERTECH

Phone: 330-57RUBIX (330-577-8249) | Email: support@rubixbattery.com